

LIFT-O-MAT Gas Spring | general

Without gas springs, today's comfort-oriented world would be less comfortable. They provide safety in function and use. Any pleasant properties that the end user experiences, increases the value perception of the respective product. Gas springs assist with lifting, lowering, opening, and closing. Gas springs dampen. They make technology comfortable.

LIFT-O-MAT gas springs are non-locking gas springs. They are used whenever components, such as doors, flaps, and lids, must be brought into a defined position. LIFT-O-MAT controls the extension force and damping action depending on the function, thereby ensuring user-friendly motion sequences.

Areas of application for LIFT-O-MAT are doors and flaps in machine and system design, automotive construction, medical technology, the furniture industry and other industrial applications.

- Advantages and properties:**
- Optimized weight compensation during lifting, lowering, opening, and closing
 - Broad selection of sizes and force variants in the standard product line
 - Flat spring characteristic curve; i.e., low force increase, even at high forces and large strokes
 - Linear, progressive, or decreasing spring characteristic curve
 - Compact design for installation in small spaces
 - Large variety of end fittings for efficient assembly
 - Damped adjustment motion over defined ranges or continuously
 - Controlled extension speed
 - Infinitely variable locking into position
 - End position locking
 - Supple or rigid behavior in the locked position
 - Additional functions, such as electric switches, STOP function, locking, etc. can be integrated

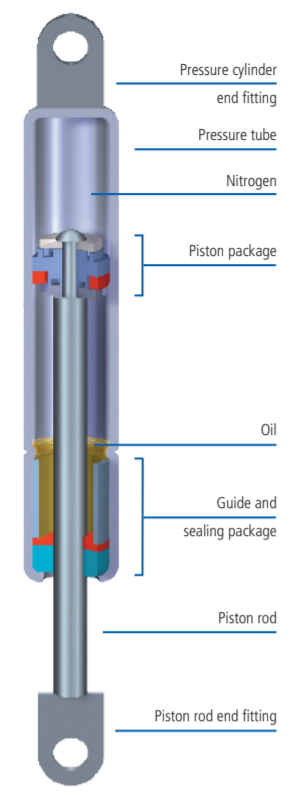

Standard LIFT-O-MAT | with hydraulic compression and extension damping

The LIFT-O-MAT with hydraulic damping has an additional oil fill. The oil reduces the speed as the end position is approached, as soon as the piston leaves the gas and enters the oil chamber. The use of patented Labyrinth pistons and the viscosity of the oil determine the damping degree; the oil amount used determines the damping range.

With the respective equipment, LIFT-O-MAT with hydraulic damping can be customized to match the task to be performed. LIFT-O-MAT provides comfortable damping in the end stop range of doors or flaps. Any unchecked force application to hinges or joints is effectively prevented; the motion sequence is controlled and harmonious.

Following the laws of gravity, the advantages of this gas spring are used according to the installation orientation: with the piston rod pointing down (extension-damped) or the piston rod pointing up (compression-damped).

- Additional advantages of the dynamic LIFT-O-MAT:**
- Simple structure
 - Excellent price/performance ratio
 - Standard product line
 - Damping in compression and extension direction possible

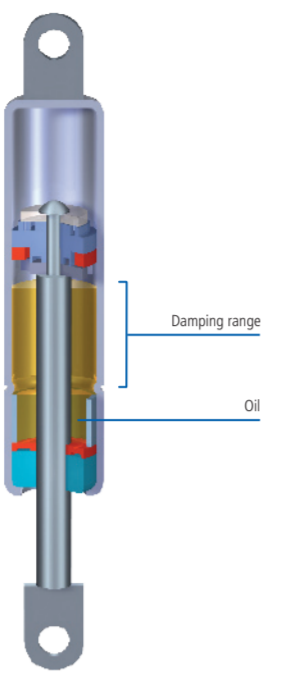

Standard LIFT-O-MAT | with dynamic compression and extension damping

The LIFT-O-MAT with dynamic damping is a gas spring whose damping properties are determined primarily through a groove in the pressure cylinder. By reducing or increasing the groove cross-section, the speed of motion can be varied over the entire stroke.

Thus, the motion can be slowed down continuously, until it comes almost to a stop. By varying the groove geometry, LIFT-O-MAT can be adapted ideally to almost any application. Different compression and extensions characteristics can be realized as well as dampened approaching of intermediate positions.

The LIFT-O-MAT with dynamic damping works regardless of its orientation, thereby approaching any position comfortably, without stressing hinges and joints.

A typical **area of application** of this LIFT-O-MAT variation include doors and flaps in machine and system design, medical technology, the furniture industry, as well as other industrial applications where the piston rod swivels from top to bottom.

- Additional advantages of the dynamic LIFT-O-MAT:**
- Function independent of installation orientation
 - Defined speed control
 - Great influence on the damping characteristics

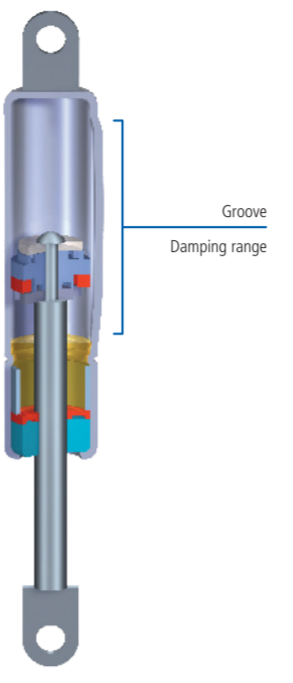

Standard LIFT-O-MAT | with decreasing or progressing spring function

A gas spring that uses additional coils affects very high or very low spring forces in the end positions, depending on the installation mode. Based on the application or requirements, rubber cushion or coil springs are used to achieve a very gentle end stop, in addition to the gas spring effect. The coil spring length and force can be adapted optimally to the respective application.

For special applications with non-linear force curves and for complex installation positions with exacting opening characteristics.

- Specific advantage of the decreasing or progressive LOM:**
- Special forces in the end position range

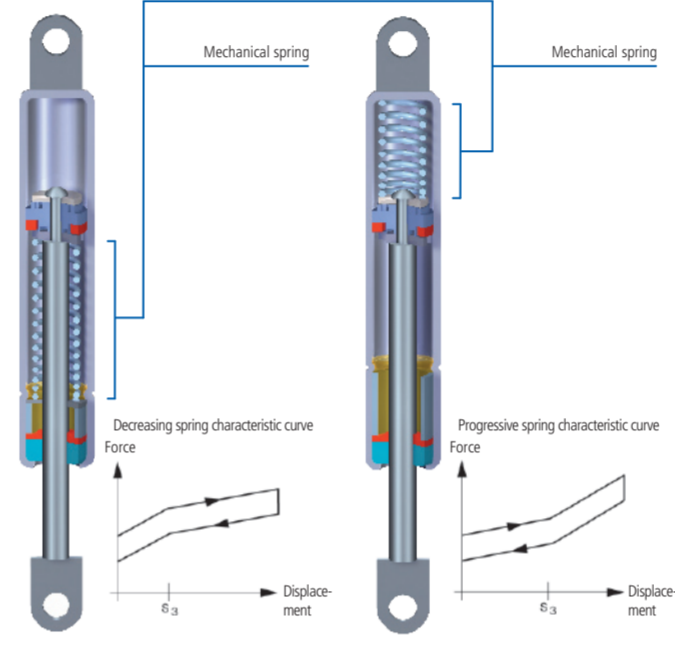
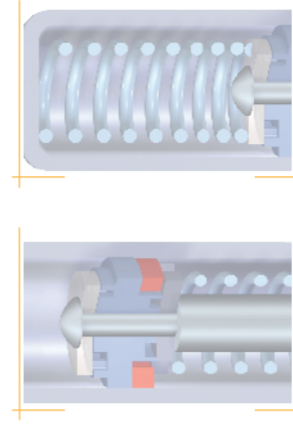

LIFT-O-MAT FR | for infinitely variable holding

The LIFT-O-MAT FR is a gas spring featuring a special piston package with an integrated friction element, which – in addition to force support – allows infinitely variable holding over the entire adjustment range. Even weight fluctuations between defined limits, for example due to varying loads, can be offset.

LIFT-O-MAT FR allows free positioning of the application, without the need to actuate a lock or release mechanism.

LIFT-O-MAT FR provides for comfort in the application and makes work easier for the user.

Its **application possibilities** are wide ranging; for example, wall cabinets in kitchen applications or free-moving arms in medical technology or in the electronics industry.

- Special advantage:**
- Ergonomic, variable positioning of the application

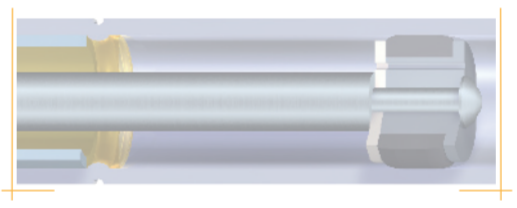
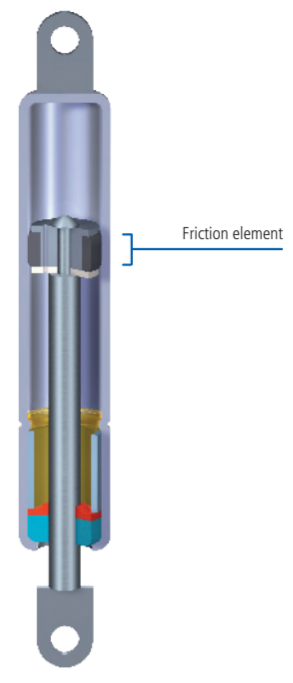

HYDRO-LIFT | gas and oil

The HYDRO-LIFT features a valve in its piston, which, in addition to user-optimized force support, allows infinitely variable positioning in the compression range. Controlled by a spring, the valve holds the position until a defined pressure, which is applied to the object by hand, opens the valve. The extension force is specified in such a manner that the gas spring does not extend by itself. Depending on the design of the HYDRO-LIFT, the hold function can be active across the entire adjustment range or in one or more partial ranges of the application.

Unlike the gas-filled version, the oil-filled HYDRO-LIFT features are limited, rigid locking in the compression direction, thereby eliminating bounce.

HYDRO-LIFT is used to safely fix the application, without the need to use a release mechanism.

Possible **areas of application** are backrest and footrest adjustment of recliners, foot panels in hospital and nursing home beds, service flaps, or roof windows.

- Special advantage:**
- Holds the application without a release mechanism

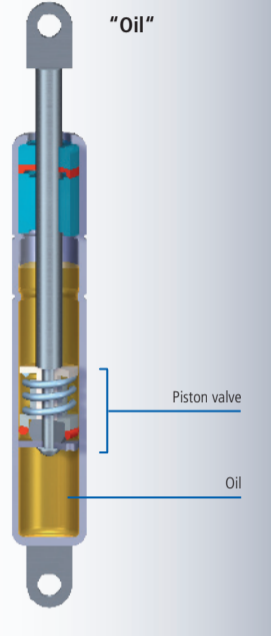
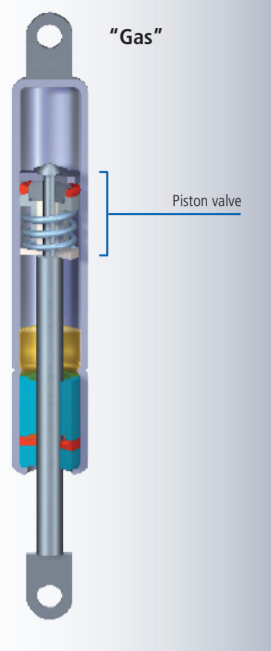

INTER-STOP | with holding range

The INTER-STOP gas spring combines the properties of the LIFT-O-MAT with dynamic damping and the holding functions of the HYDRO-LIFT, with the holding force working in the extension direction. The stroke can be divided into one or more function areas.

For example, one function area might perform the stopping or hold the application load in any position, until a manual force is applied, for example by hand.

Then there might be an additional range for free extension with force support, which could be stopped at a defined point.

The compression function of the gas spring is the same as in a standard LIFT-O-MAT.

- Special advantage:**
- Wide variety of opening functions

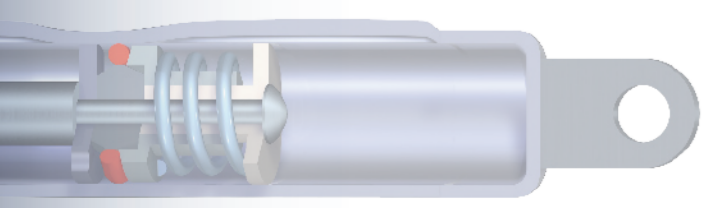
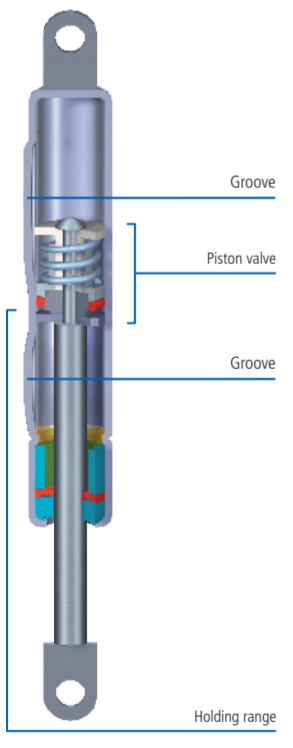

LIFT-O-MAT PTL | with stop in the compressed position

The LIFT-O-MAT PTL is a gas spring with an additional mechanical lock in the compressed position.

Similar to the ball point pen principle, the lock can be released by a light push; the gas spring then extends by itself.

Besides the force support function, LIFT-O-MAT PTL features an end position stop, thereby eliminating the need for additional fixing elements. At the same time, LIFT-O-MAT PTL is easy and comfortable to use.

The LIFT-O-MAT PTL is used especially in furniture, e.g.: in recessed connector strips in conference tables, bar compartments, backrests of sofas, armrests, and headrests adjustment.

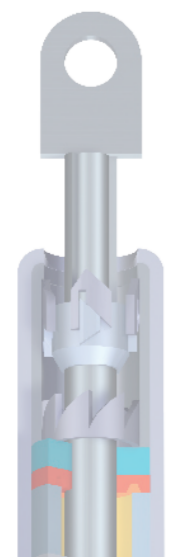
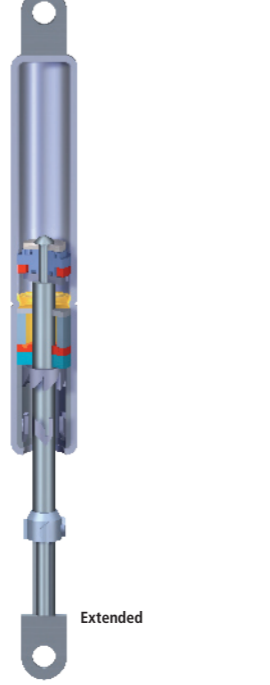
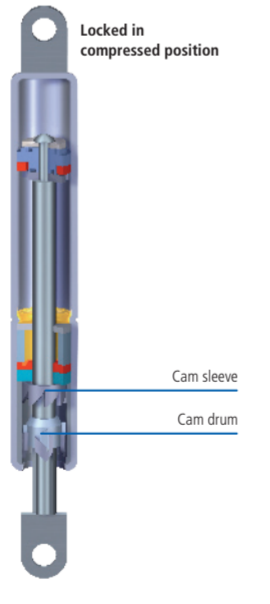

LIFT-O-MAT | with end position stop in the extended position

In addition to force support, the LIFT-O-MAT gas spring with end position stop also provides a safe mechanical lock of the application in the extended position. As a rule, two variations are available:

In the gas spring with the stop on the outside, a support tube at the end of the piston rod folds out automatically. To unlock, the support tube is swiveled back into the central position.

The lock of a gas spring with the lock on the inside is comparable with the mechanics of a ball point pen. A light push on the piston rod in the extended position locks it; a quick movement in the extension direction releases the lock.

A lock is always necessary or recommended, if the application needs to be protected against accidental adjustment or if the application is subject to forces that exceed the extension force of the spring. Such forces could be wind or snow loads affecting the application.

Typical **areas of application** are heavy doors on harvesters or bale presses, trailers for street vendors and street fairs.

- Specific advantages:**
- Releasing the gas spring and adjusting the application with only one hand!
 - No need to install additional fixing elements

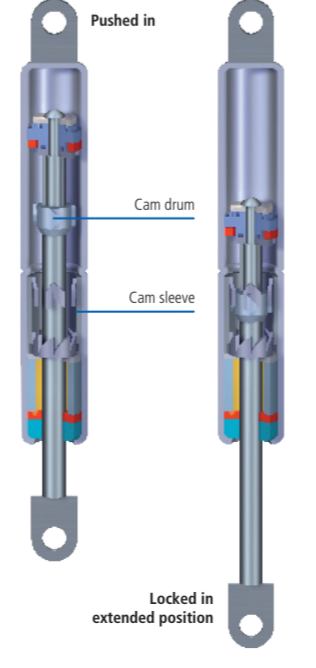
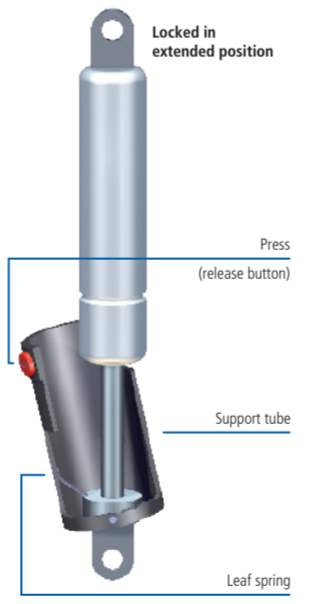

KOMBI-LIFT | with lever

The KOMBI-LIFT is a combination of locking and non-locking gas springs; that is, a specified segment of the stroke can lock during extension. It is locked by actuating the lever on the piston rod. The function areas can be arranged in any form over the entire stroke.

It can be compressed independent of the lever position, like a standard LIFT-O-MAT.

Instead of a lever, all available actuation systems of the BLOC-O-LIFT can be used as well.

A typical **area of application** is the door and flap limitation in utility vehicle cab design.

- Advantage:**
- Combined functionality for special applications

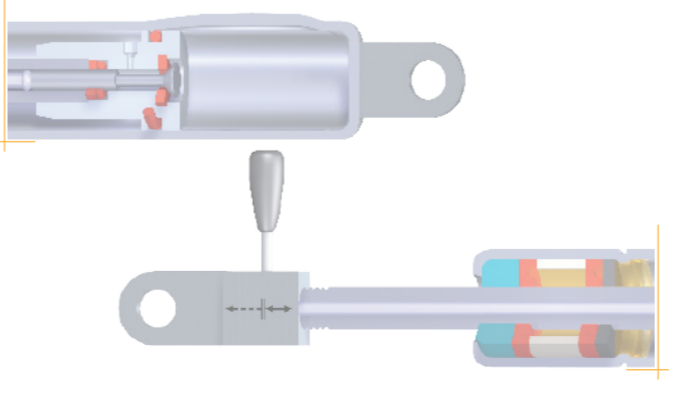
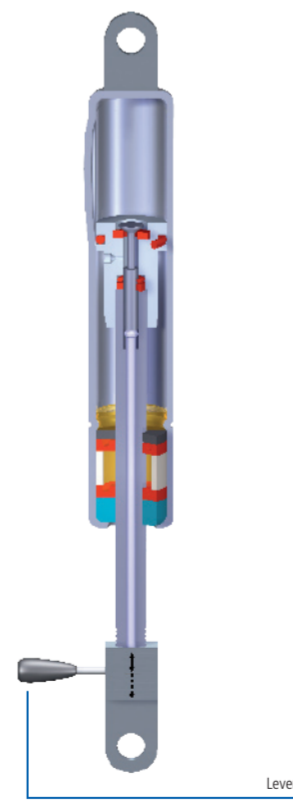

LIFT-O-MAT INOX LINE | stainless steel

The LIFT-O-MAT INOX LINE is a gas spring that is particularly corrosion resistant due to the use of V4A steel (see DIN EN 100 88-1).

LIFT-O-MAT Inox Line is non-magnetic. The oils used as fluids are biodegradable and are classified as "no hazard to water" in the water hazard class (WGK).

The LIFT-O-MAT INOX LINE is used in corrosive environments, e.g., in sea air or industrial exhaust gases. They provide very good corrosion protection, even in acid or alkaline environments.

Typical **areas of application** are environmental and water supply technology, the food industry, plant construction, shipbuilding, chemical industry, as well as military technology.

- Specific advantages:**
- High corrosion protection
 - Non-magnetic
 - Environmentally friendly components

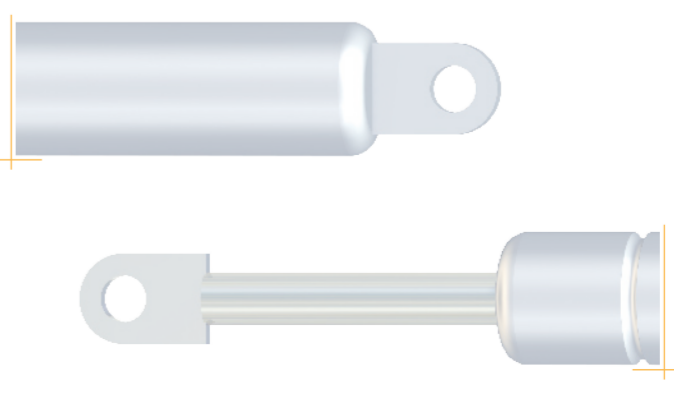
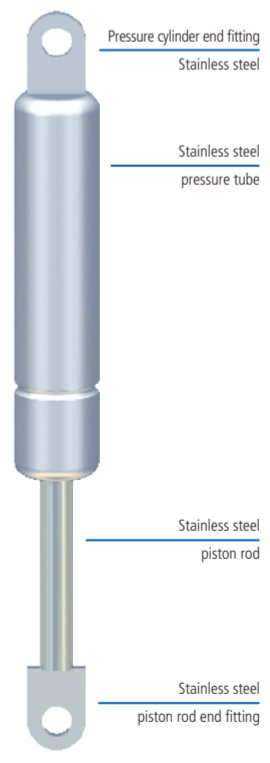

Miscellaneous end fittings

Depending on the function as well as the manufacture/assembly, STABILUS offers a broad variety of end fittings and joints made of plastic and metal, which can be screwed on torsion-free. Here you will find a selection of popular end fittings.

We will gladly help you with your ideal solution.



A small selection of available end fittings

BLOC-O-LIFT Gas Spring
| general

The BLOC-O-LIFT gas springs are so-called locking gas springs. They are used for functions such as adjustments with force support, damping, as well as infinitely variable locking. This is achieved with a special piston valve system. If the valve is open, BLOC-O-LIFT provides force support and damping. If the valve is closed, the gas spring locks and provides high resistance to any motion.

Basically, there are two types of valve design: a sliding valve with standard actuation of 2.5 mm, and the seat valve with an actuation of 1 mm for extremely short actuation distances.

BLOC-O-LIFT can have spring or rigid locking. The rigid locking version is available as orientation-specific or non-orientation specific. Depending on the application, BLOC-O-LIFT can be equipped with a patented, corrosion-free actuation tappet.

Primary application areas for BLOC-O-LIFT gas springs are furniture manufacture, medical technology, building technology, aviation and aeronautics, automotive design, and many industrial applications.

Advantage:

- Infinitely variable locking into position

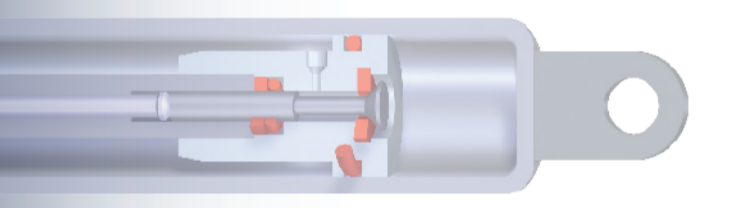
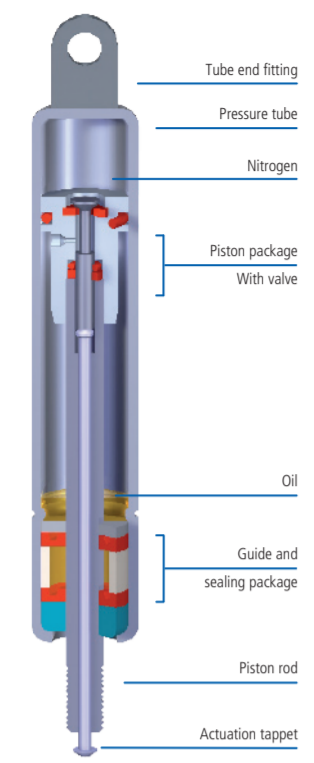

BLOC-O-LIFT
| rigid, locking, can be mounted in any orientation

Unlike the purely gas-filled BLOC-O-LIFT, where the gas characteristics cause spring locking, in this type of BLOC-O-LIFT, the entire working range of the piston is filled with oil. Depending on the installation of so-called separating pistons, which separate the gas chamber from the oil chamber, different locking forces can be achieved in the extension or compression directions. The maximum allowable locking force depends on the extension force and/or the overall device strength.

Specific advantages:

- Very high oil locking force
- Can be installed in any orientation

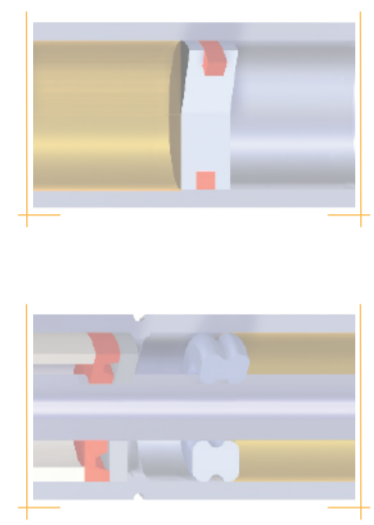
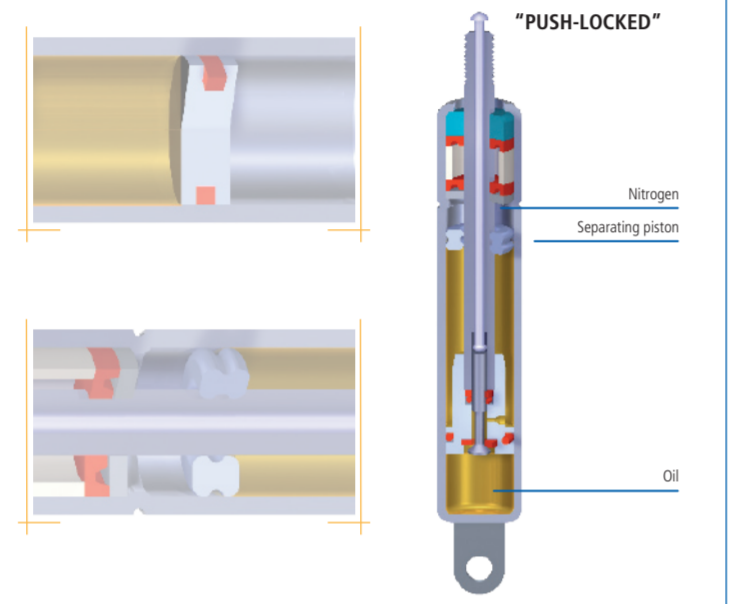

BLOC-O-LIFT
| rigid locking, vertical installation

In this version of rigid locking gas springs, the entire working range of the piston is in oil, resulting in rigid locking, since oil cannot be compressed. Unlike the orientation-independent BLOC-O-LIFT, separating pistons were foregone in favor of lower costs. Flawless function is maintained by gravity; therefore, vertical or almost vertical installation must be ensured. Here, the alignment of the piston rod defines the locking behavior in the pull or push direction.

Same **areas of application** as for the BLOC-O-LIFT described before.

Advantage:

- Cost-effective

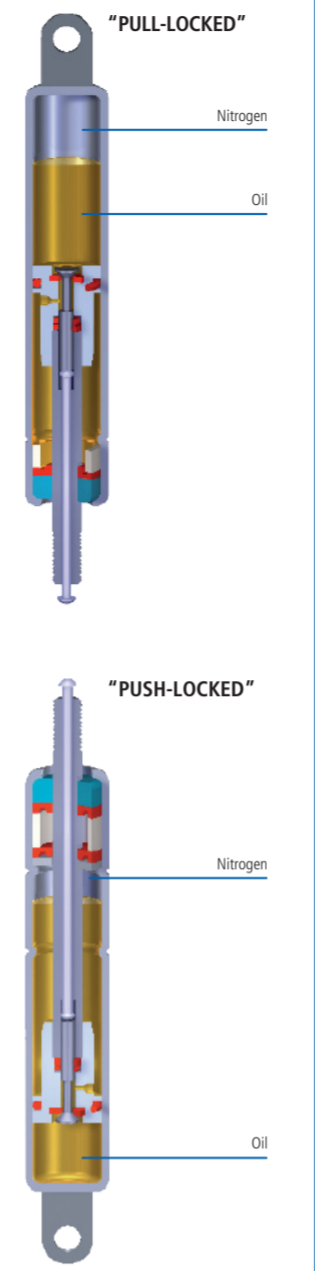

BLOC-O-LIFT
| with override function

A special form of this BLOC-O-LIFT gas spring is the additional override function. This function, which was designed for special customer requests, is to protect the application from overload.

The override function is available for tension and compression direction; it can be realized in locking gas springs featuring orientation-independent or vertical installation. The override force can be freely defined within certain limits.

The BLOC-O-LIFT override function is **used in** backrest and footrest adjustment of chairs and beds, or in foot panel adjustments of treatment tables and beds.

Specific advantage:

- Overload protection

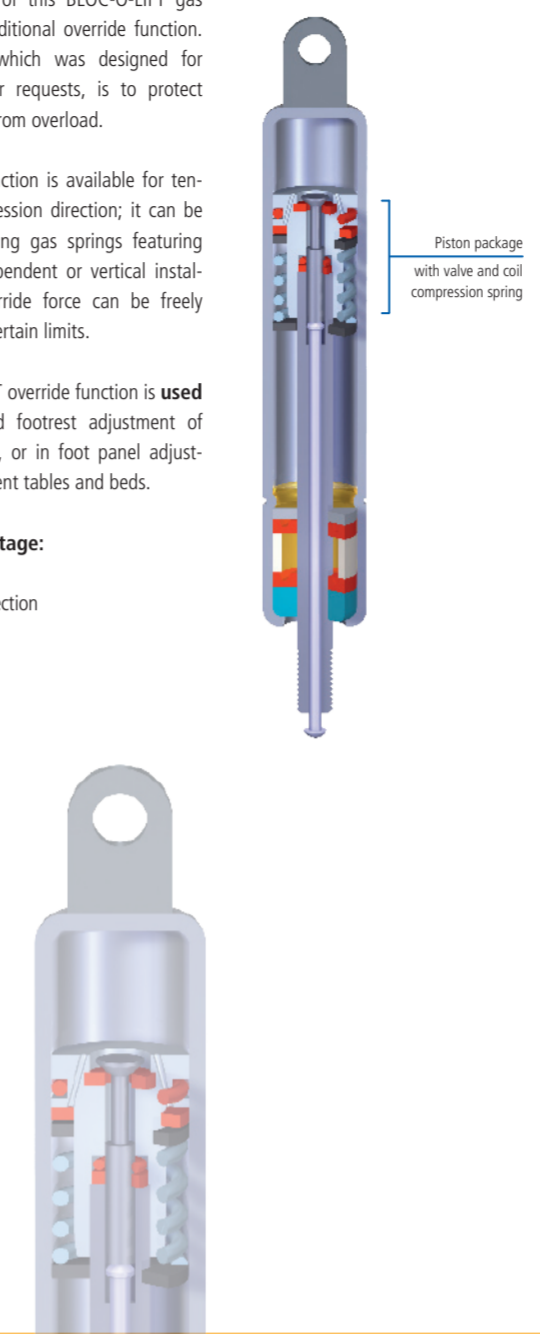

BLOC-O-LIFT OBT
| without locking in extension direction

BLOC-O-LIFT OBT permits comfortable upward movements of applications, such as table tops, without the need to actuate a release. This is made possible by a special valve system in the piston package.

In the compression direction, BLOC-O-LIFT OBT can be locked in any direction.

Usually, the OBT function of gas springs is used in vertical installations.

Typical **areas of application** are table adjustment systems in hospital nightstands and in student furniture.

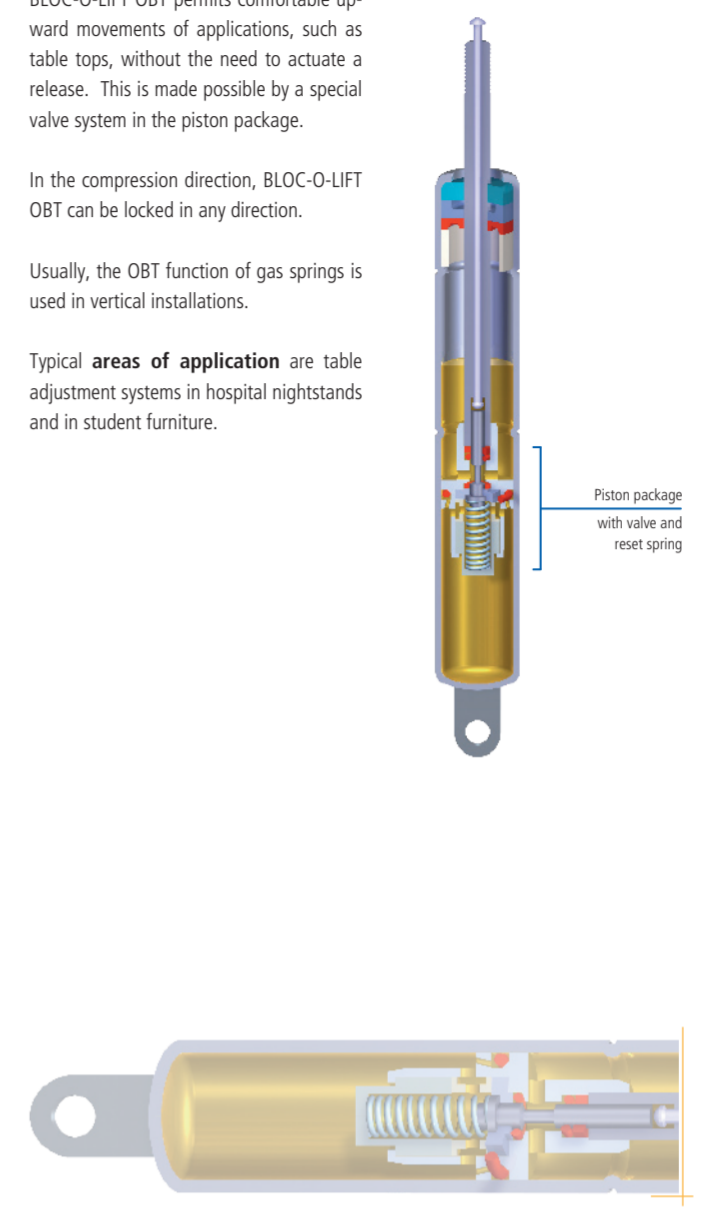

... macht Technik komfortabel

BLOC-O-LIFT T
| with especially flat spring characteristic curve

BLOC-O-LIFT T is the design of a gas spring with a particularly flat spring characteristic curve, providing an almost even force over the entire stroke. It provides precise, comfortable adjustment and locking of the application. BLOC-O-LIFT T stands out due to its compact design and can be mounted in any position. The actuation mechanism can be operated by hand or foot, via lever or Bowden cable.

The BLOC-O-LIFT T has been installed successfully in furniture, especially in single and double-column tables, desks, nightstands, or height-adjustable desk tops.

Specific advantage:

- Even force distribution over the entire stroke
- Compact design with a long stroke

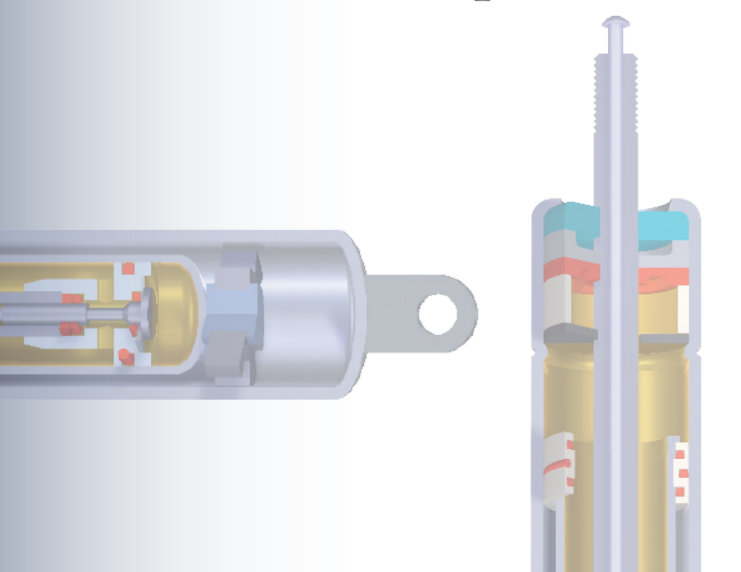
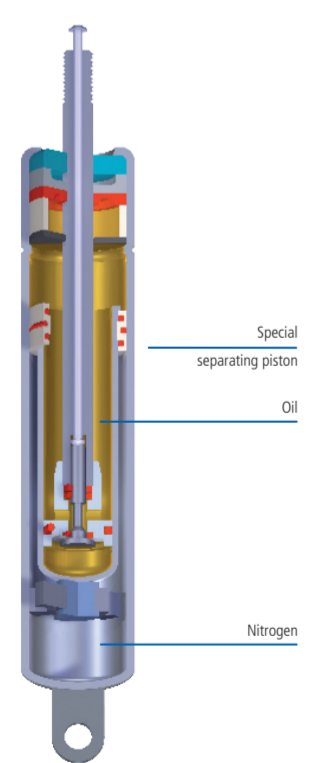

BLOC-O-LIFT
| actuation systems

Stabilus offers different actuation systems for the BLOC-O-LIFT gas spring.

Different release heads with lever are available for applications with direct actuation on the gas spring.

Bowden cables are used for indirect actuation, i.e., not on the gas spring itself. This system consists of a release head, a Bowden cable, and the actuation unit.

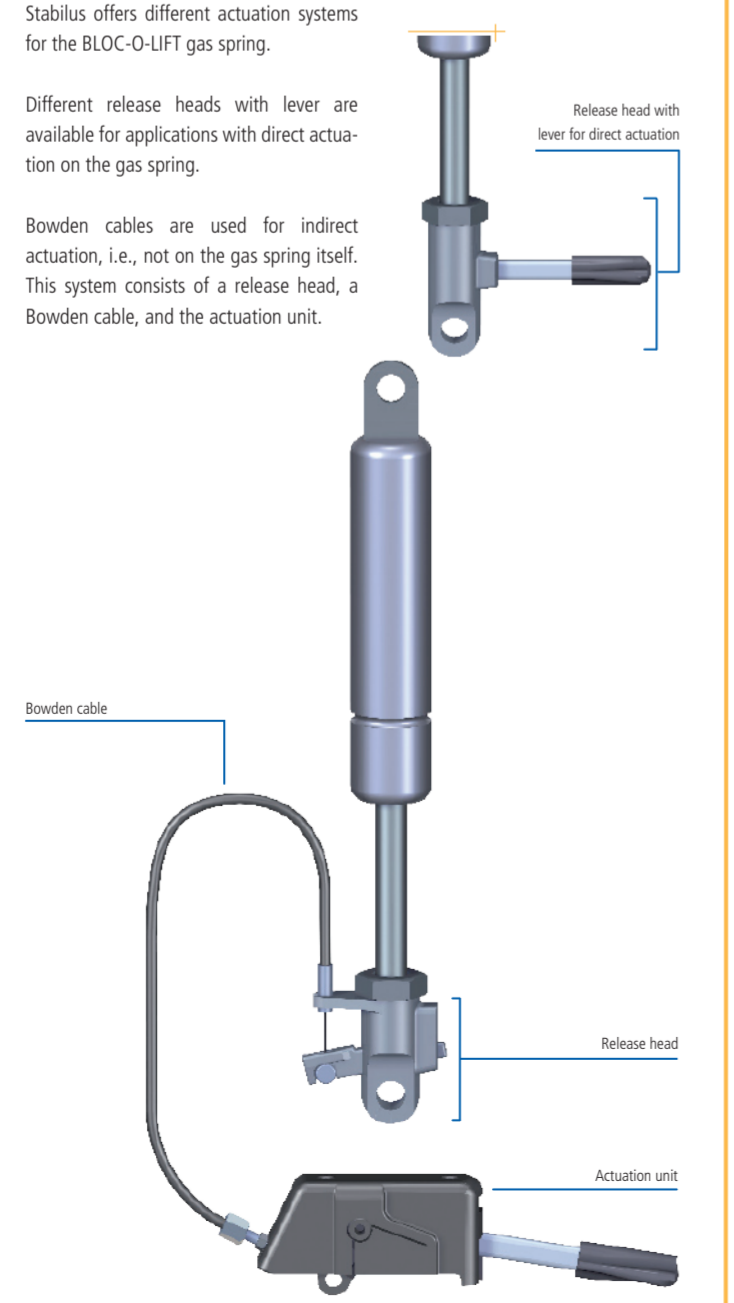

STAB-O-SHOC
| for low damping forces

The standard STAB-O-SHOC HD15 is a hydraulic damper without extension force. STAB-O-SHOC HD15 is orientation-specific and achieves its optimum function in almost vertical installation with force transmission without a return stroke, in one direction of movement. Horizontal **special variations** are possible, as are models providing force support during extension or length-controlled damping.

Typical **areas of application** are automotive design, plant design, industrial applications, and the furniture industry. Here, the simple STAB-O-SHOC HD15 is used as a motion damper in flap systems, allowing gentle opening or closing.

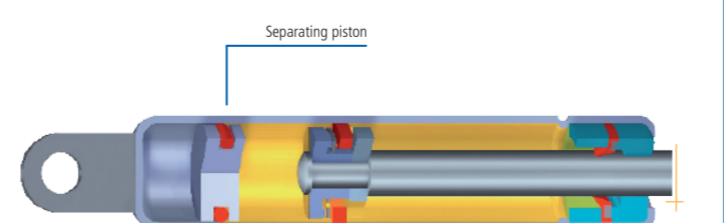
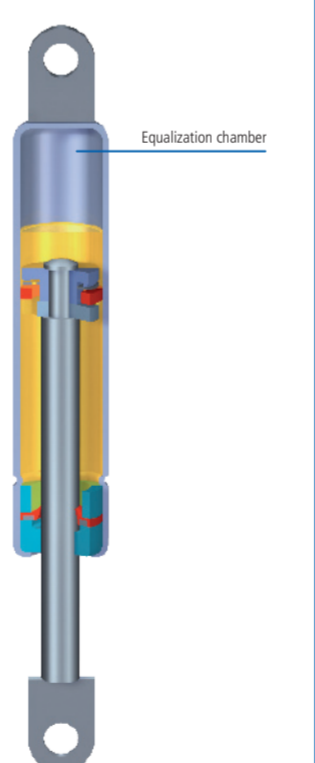

STAB-O-SHOC
| for high loads

STAB-O-SHOC HD24/HD29 is a hydraulic **vibration damper** for high loads. The dampers are orientation-specific as standard.

STABILUS also provides a wide range of special forms, for example for force transmission without a return stroke in any direction of movement. The characteristic curve can be adapted individually at the factory. Different piston variations allow decreasing, progressive, or almost linear curves. Pressure-loaded and length-controlled variations are also possible.

Areas of application are, among others, seat dampers, washing machines, and motion dampers with high force requirements for especially heavy flaps.

One **special design** is the overrunning brake damper in automotive design.

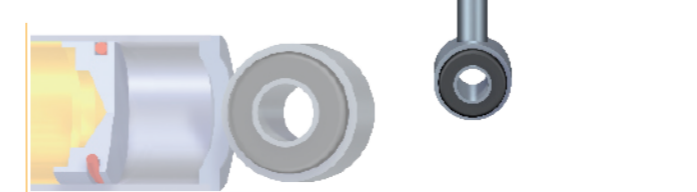
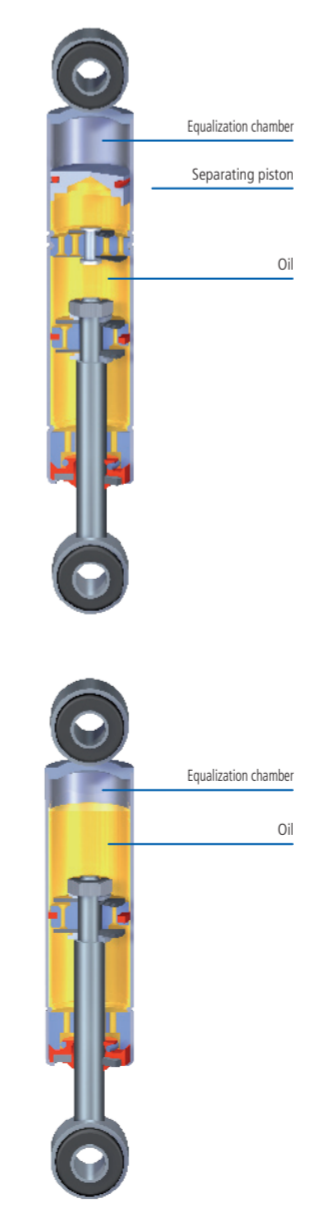

STAB-O-SHOC
| for the smallest installation lengths

The TA20 damper is a high-performance, non-pressure, hydraulic vibration damper. It is not orientation-specific, meaning that force transmission without a return stroke is possible in any installation position. Equipping the outside of the pressure tube with a diaphragm allows very short installation lengths.

TA dampers are available in different dimensions, even for high loads. The damper characteristic curve can be adapted to the respective application at the factory.

Specific **areas of application** in utility vehicles are steering dampers in trailing axles or medical technology, e.g., backrest adjustments in hospital and nursing home beds.

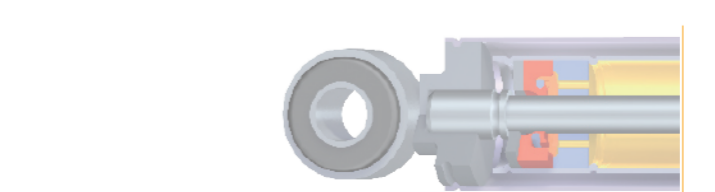
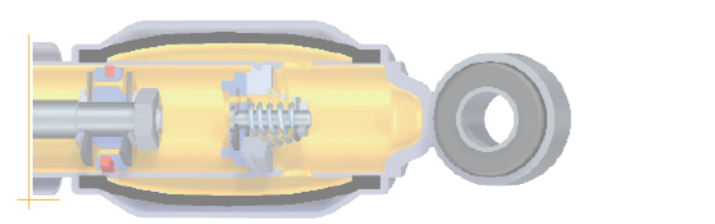
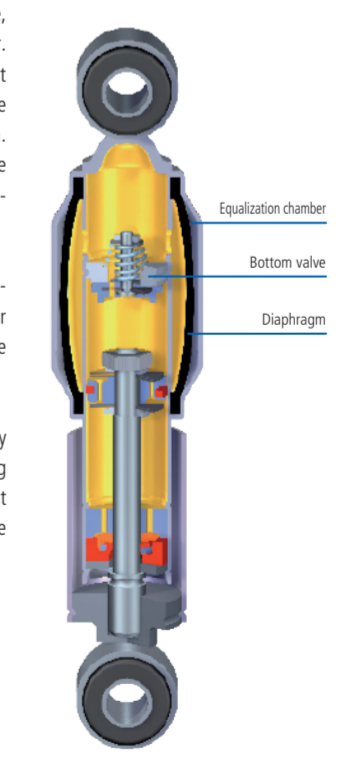

STABILUS

Individual Solutions for Many Applications

With its gas springs and hydraulic vibration dampers, STABILUS is the world market leader with an annual production of more than 120 million units.

By now, the range of applications for STABILUS products is nearly unlimited. In many areas, STABILUS products make everyday life easier and simply more comfortable.

STABILUS is known for technical innovation, quality, and competitive pricing. Of course, individual, extensive consultation and support with installation in the application can be taken for granted with STABILUS.

The STABILUS application consultants and technicians will work out optimized solutions for you and will be glad to fine-tune them with you on-site.

Stabilus GmbH
Wallersheimer Weg 100
56070 Koblenz
Germany
Telefon: ++49-261-8900-0
Fax: ++49-261-8900-204
E-Mail: info@de.stabilus.com

www.stabilus.de

11/06

... macht Technik komfortabel