

Technical documentation

Wire Race Bearings with Rectangular Profile Type LER



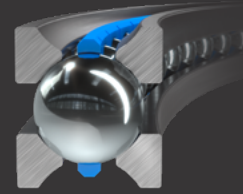

Table of contents

	page		page
1. Type LER		6. Rotational resistance and concentricity	10
1.1 Overview	3	7. Assemble gaskets	12
2. Calculation basis		8. Maintenance	
2.1 Terms, unit of measurement.....	4	8.1 Safety instructions for maintenance	13
2.2 Static calculation	4	8.2 Maintenance work	14
2.2.1 Axial and radial factors		8.2.1 Relubrication	
2.2.2 Recommended static safety S_{st}		9. Tools and accessoires	
2.3 Dynamic calculation.....	5	9.1 Tools needed.....	16
2.3.1 Nominal lifetime		9.2 Accessoires.....	16
2.3.2 Axial and radial loads		10. Imprint	16
2.3.3 Axial and moment load and axial load with $F_r = 0, M_k = 0$			
2.3.4 Radial and moment load and radial load with $F_a = 0, M_k = 0$			
3. Construcion wire bed	6		
3.1 Construction examples.....	6		
4. Reconciliation options			
4.1 Reconciliation by reconciliation inserts	7		
4.2 Reconciliation by threaded rings	8		
4.3 Reconciliation by grinding (massive reconciliation)	8		
4.4 Installation without tuning.....	8		
5. Assembly	9		

1. Type LER

1.1 Overview

Size	Representation
<p>LER 1.5</p> <p>KKØ 40 - 150 mm</p>	
<p>LER 2</p> <p>KKØ 80 - 400 mm</p>	
<p>LER 3</p> <p>KKØ 100 - 1500 mm</p>	
<p>LER 4</p> <p>KKØ 200 - 1500 mm</p>	
<p>LER 5</p> <p>KKØ 250 - 1800 mm</p>	

2. Calculation basis

All forces and moments acting on the bearing are to be summarized by vectorial addition into centrally acting forces F_a and F_r as well as resulting moments M_k . For complex load cases and load collectives with variable load and speed, we will be pleased to perform the calculation for you.

2.1 Terms, unit of measurement

C	dynamic load rating	(N)
C_0	static load rating	(N)
F_a	centrally acting axial force	(N)
F_r	centrally acting radial force	(N)
KKØ	Ball race diameter = (D + d)/2	(M)
L_n	nominal life	(h)
M_k	tilting moment	(Nm)
n	rotational speed	(min - 1)
P	dynamic equivalent load	(N)
P_0	statically equivalent load	(N)
S_{st}	static safety	
X	Radial factor	
Y	Axial factor	
Z	Moment faktor	

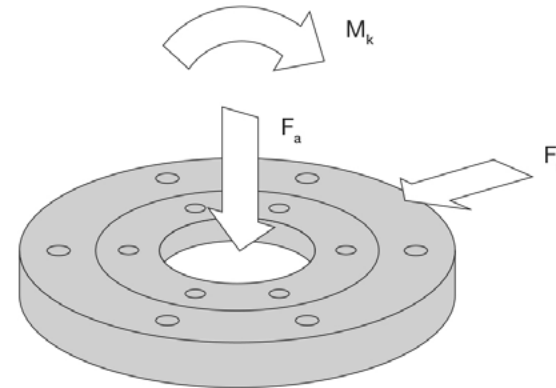

2.2 Static calculation

A static calculation is sufficient if the bearing is loaded at standstill. A bearing with sufficient load carrying capacity has been selected if the recommended static safety is achieved.

$$S_{st} = \frac{1}{\frac{F_a}{C_{oa}} + \frac{F_r}{C_{or}} + \frac{M}{C_{om}}}$$

2.2.1 Axial and radial factors

	X_0	Y_0
All bearing types	1.0	0.47

2.2.2 Recommended static safety S_{st}

Ball diameter > 6	S_{st}
With quiet, vibration-free operation	> 1.8
During normal operation	> 2.5
With pronounced shock loads and high requirements on running accuracy	> 8.0

2.3 Dynamic calculation

For a circulating speed of $v > 0.1$ m/s, a static and dynamic calculation is required, whereby the static safety S_{st} must reach at least the recommended value of the respective load (Table 2.2.2).

2.3.1 Nominal life

$$L_n = \left(\frac{C}{P}\right)^3 \cdot \frac{10^6}{60 \cdot n} \quad (h)$$

2.3.2 Axial and radial loads

$$P = X \cdot F_r + Y \cdot F_a \quad (N)$$

	$\frac{F_a}{F_r} \geq 1$		$\frac{F_a}{F_r} < 1$	
	X	Y	X	Y
All bearing types	1.26	0.45	0.86	0.86

2.3.3 Axial and moment load and axial load with $F_r = 0, M_k = 0$

$$P = Y \cdot F_a + Z \cdot \frac{M_k}{KKØ} \quad (N)$$

	$0 < \frac{M_k}{F_a \cdot KKØ} \leq 0,5$		$\frac{M_k}{F_a \cdot KKØ} \geq 0,5$	
	Y	Z	Y	Z
All bearing types	0.86	1.72	0.45	2.54

2.3.4 Radial and moment load and radial load with $F_a = 0, M_k = 0$

$$P = X \cdot F_r + Z \cdot \frac{M_k}{KKØ} \quad (N)$$

	$0 \leq \frac{M_k}{F_r \cdot KKØ} \leq 0,5$		$\frac{M_k}{F_r \cdot KKØ} \geq 0,5$	
	X	Z	X	Z
All bearing types	1.0	1.68	0.86	1,96

We will be pleased to perform the calculation for you for the load case radial, axial and moment load.

3. Construction wire bed

The bearing elements LER offer a geometry that is very easy to manufacture with regard to the production of the enclosing turned parts. Here it is possible to adjust the bearing via a simple cover plate and shims, no centering on the split ring is required.

Also in the case of the design with cover, care must be taken in the design of the surrounding parts that the dimension N on the wire bed, which is provided with cover, is produced with undersize in order to be able to achieve the desired preload in the bearing by adding shims.

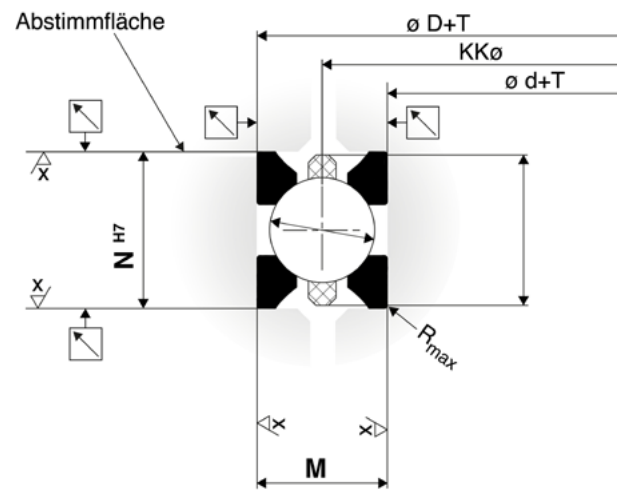

The wire bed has no radii which accommodate the race. However, care must be taken in the design that the tool radii are not greater than 0.2 mm.

$$T = KK\varnothing / 10.000 \text{ (Dimensions in mm)}$$

Undersize for reconciliation inserts: 0.1 mm

From a design point of view, it makes sense to make the stator of the bearing split, the rotor should be one-piece. The accuracy to be achieved is influenced by the individual accuracies. However, since the wire bed of the split ring also has no offset in the radial runout, the radial and axial runout tolerances are divided in half between the two rings in this case.

The roundness of the wire bed is generally based on half the diameter tolerance, and the bolt-on surface of the adjacent construction is used as the basis for the axial runout of the wire bed. The basis for radial runout is generally the centerline of the wire bed.

Flatness and parallelism of the individual parts are designed with half of the total tolerance. The locating fit of the bearing is to be machined together with the wire bed in one clamping operation. It is sufficient to produce the wire bed by turning or milling; surface finishes of $R_a 3.2$ should be aimed for, since the setting behavior of the bearing is positively influenced by high surface finish.

3.1 Construction examples

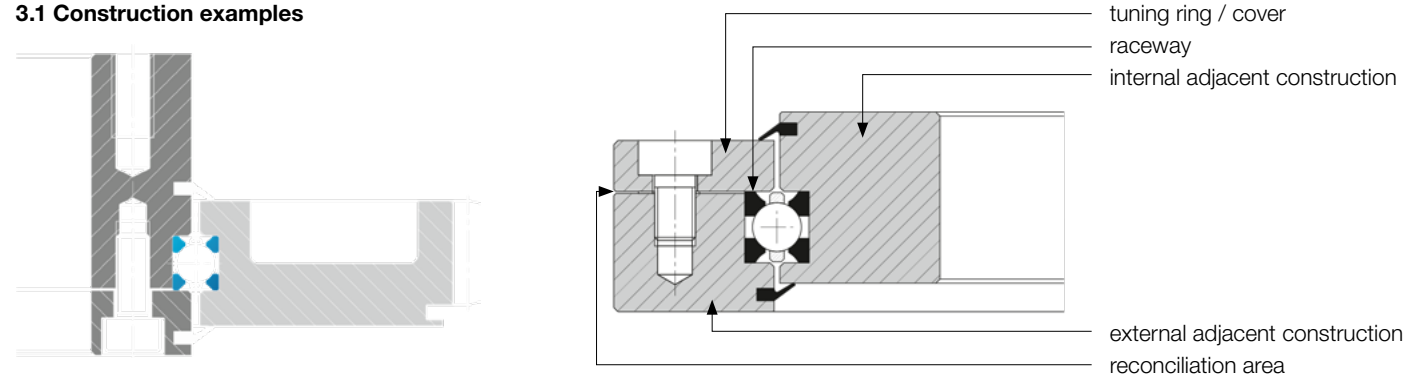

4. Reconciliation options

4.1 Reconciliation by reconciliation inserts

When designing the enclosing parts, care must be taken to ensure that the two housing parts to be joined are undersized so that the desired preload can be achieved in the bearing by adding shims.

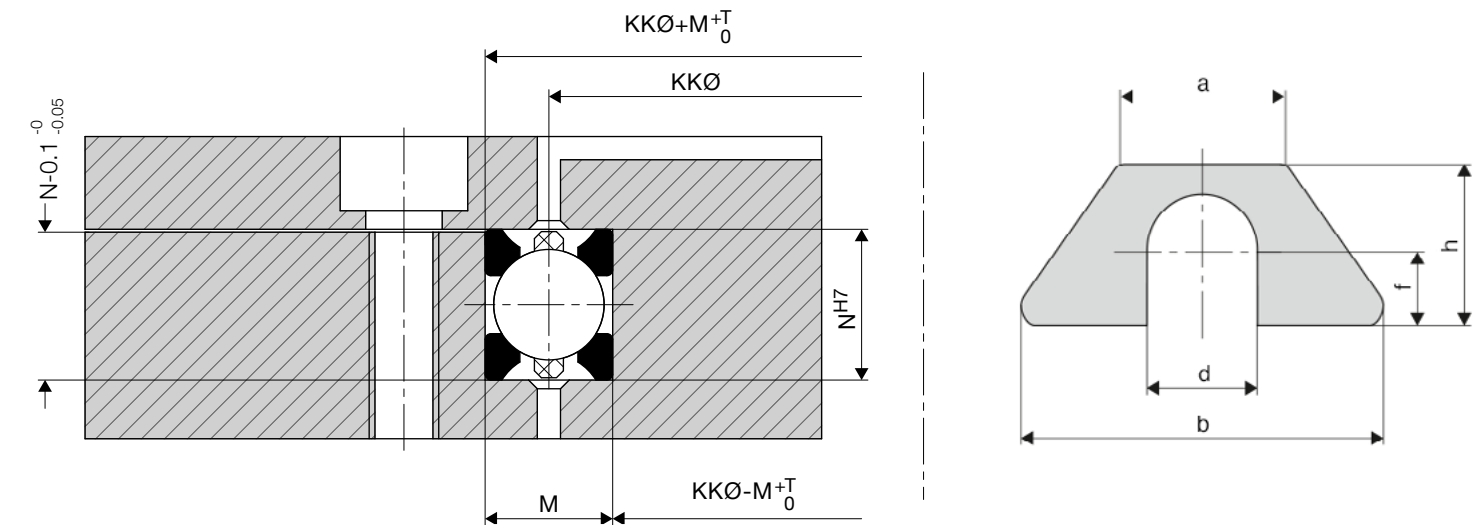

Size	dimensions (mm)					order no. thickness (mm)							
	a	b	d	f	h	0.025	0.1	0.15	0.2	0.25	0.3	0.5	1.0
M 6	11.0	24.4	7.0	5.0	11.0	79015A	79034A	79035A	79036A	79037A	79038A	79039A	79040A
M 8	14.7	34.2	9.0	6.0	13.5	79041A	79023A	79042A	79000A	79026A	79043A	79044A	79045A
M 10	16.4	42.3	11.0	7.0	16.0	79046A	79012A	79010A	79011A	79047A	79048A	79049A	79050A
M 12	20.3	46.0	13.0	8.0	18.0	79118A	79051A	79052A	79053A	79054A	79055A	79056A	79065A
M 16	25.4	54.0	17.0	11.0	24.0	79119A	79024A	79066A	79057A	79058A	79059A	79060A	79061A

4.2 Tuning by threaded ring

The use of LER bearing elements is recommended here. The wire bed diameters can be manufactured undivided, then the setting of the bearing is adjusted by screwing in the threaded ring.

After correct bearing adjustment, this must be secured by means of a grub screw. After the bearing has been set correctly. For the thread pitch 1.5 or 2 mm are recommended.

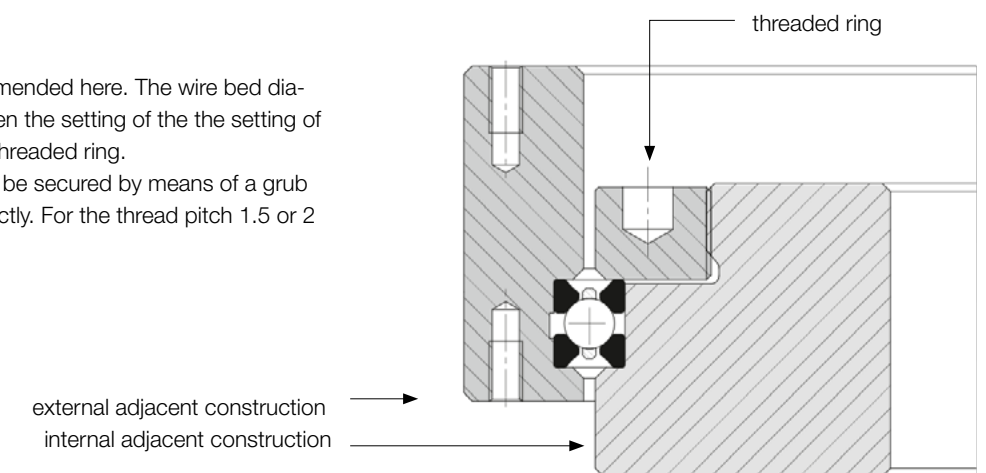

4.3 Reconciliation by grinding (massive reconciliation)

When designing the enclosing parts, care must be taken to ensure that the two housing parts to be joined are manufactured with oversize in order to be able to achieve the desired preload in the bearing by grinding off the cover. The tuning surface and mounting base for grinding must be parallel!

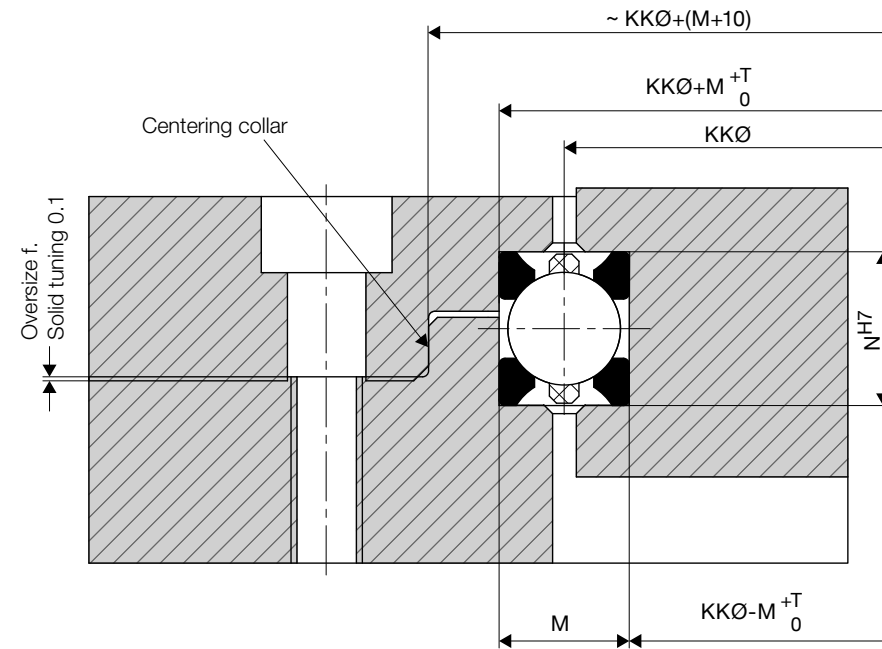

4.4 Installation without tuning

If a bearing clearance of 0 - 0.1 mm is not a problem, the wire race bearing type LER can also be mounted without tuning. Wire bed diameter and dimension N are to be manufactured according to the table. If the permissible clearance is larger, the tolerances can also be extended if necessary. tolerances can be extended if necessary. If the bearing has play, running noise must be expected.

Type	Wire bed exterior-Ø mm	Wire bed interior-Ø mm	N mm
LER 3	$(KKØ+11.02)_{-0.04}$	$(KKØ-11.02)_{+0.04}$	13 ^{H7}
LER 4	$(KKØ+14.02)_{-0.04}$	$(KKØ-14.02)_{-0.04}$	16 ^{H7}
LER5	$(KKØ+15.80)_{-0.04}$	$(KKØ-15.80)_{-0.04}$	17.5 ^{H7}

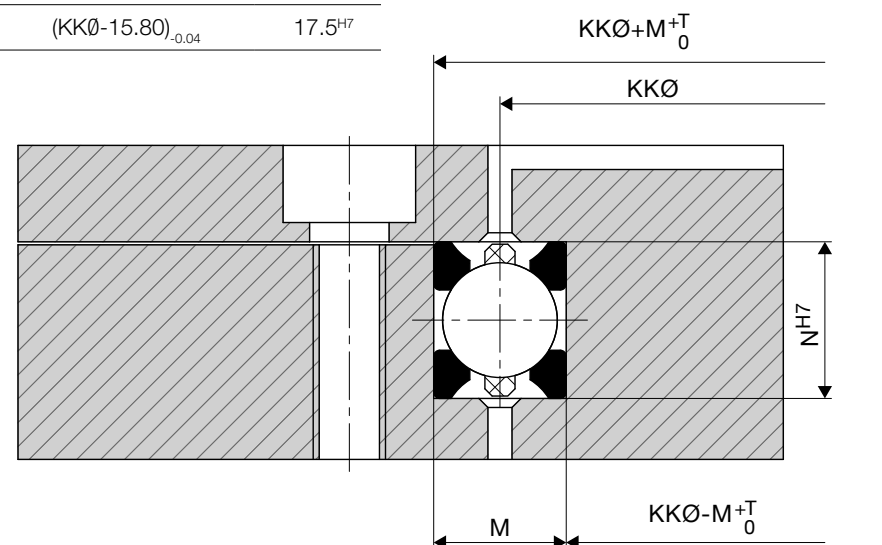

5. Assembly



The mounting of the bearing elements must be carried out at a clean workplace. There must be sufficient space for the bearing elements at the mounting location and the support must ensure sufficient stability.

Before mounting, the races must be cleaned. To do this, use a clean, lint-free cloth to remove the remains of anti-corrosion agent and impurities on the raceways.

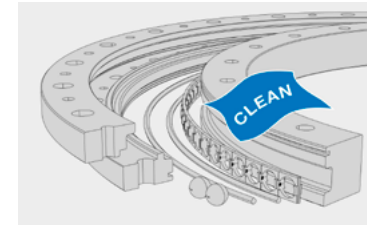

Clean components

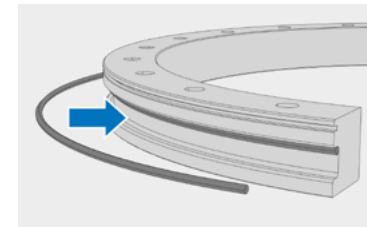

Insert race rings

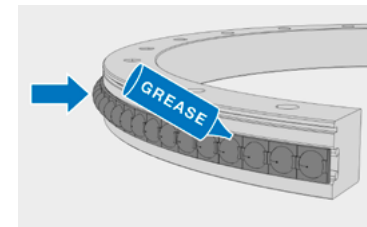

Insert cage with balls

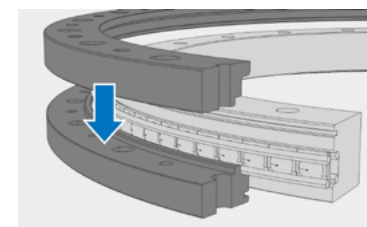

Close bearing

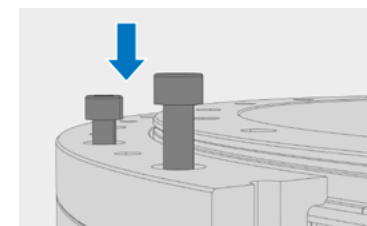

Screwing

- 1 Clean components with a clean, lint-free cloth.



To keep the races in position during installation, apply a little grease to the seat of the races in the inner and outer adjacent construction.

- 2 Insert the races into the inner and outer adjacent construction. Observe the diameters of the races. Insert the races so that the ground or profiled raceways are aligned with each other and the joints are offset by 180°.

- 3 Grease the cage and insert it into the undivided adjacent construction.



Only use the balls enclosed in the delivery. If balls are lost, all balls must be replaced so as not to impair the running properties and functionality of the bearing.

For recommended lubricants, see page 16

- 4 Close the bearing on the split side. Make sure that the hole pattern of the split outer ring matches.

- 5 Insert the retaining screws in the holes provided. Only use screws with a screw strength class of at least 8.8.

- 6 Adjust bearings with shims, by solid tuning or screwing in the threaded ring to the correct rotational resistance.

6. Rotational resistance and concentricity

The following data are recommendations of the rotational resistance to be set. The concentricity shown can be achieved depending on the manufacturing tolerances of the.

LER 1.5

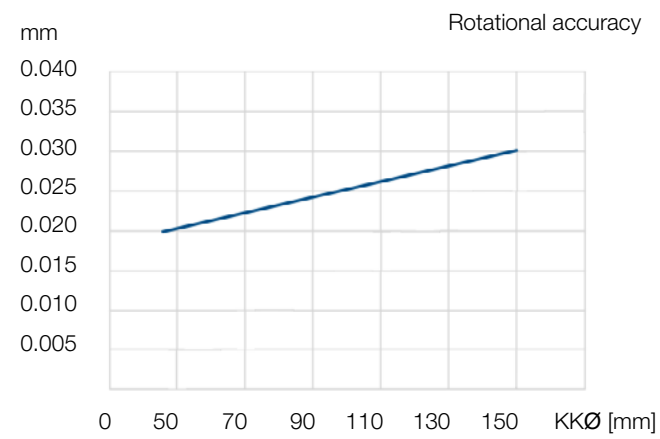
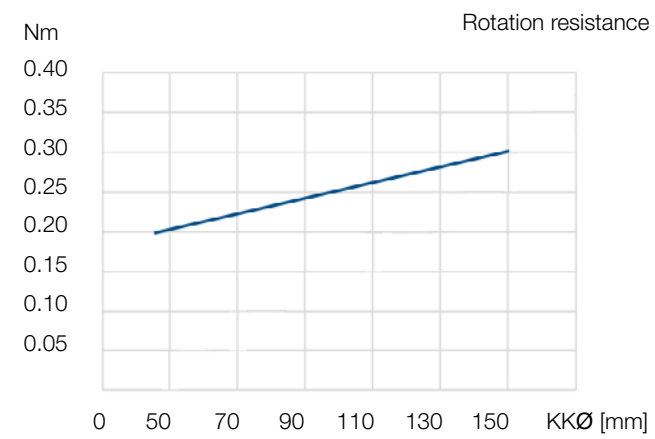

LER 2

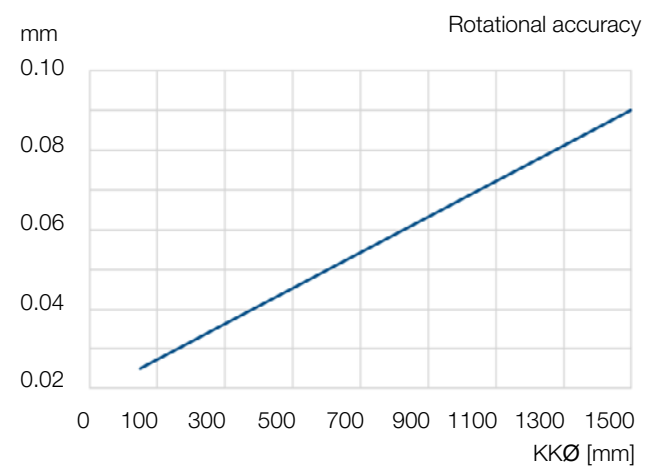
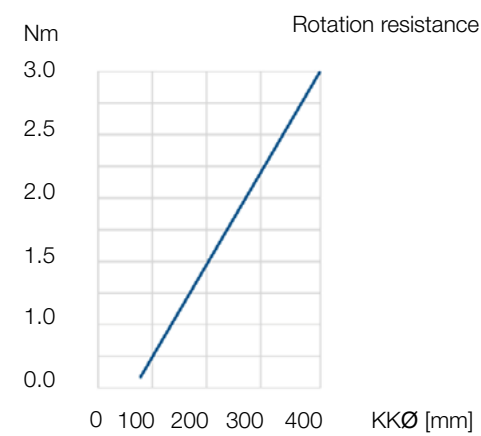

LER 3

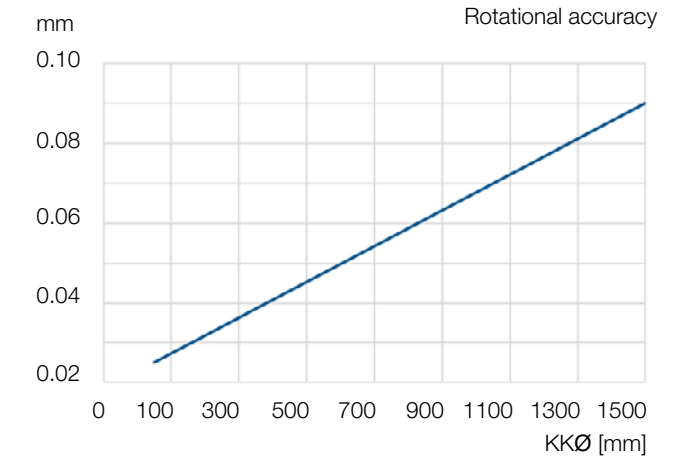
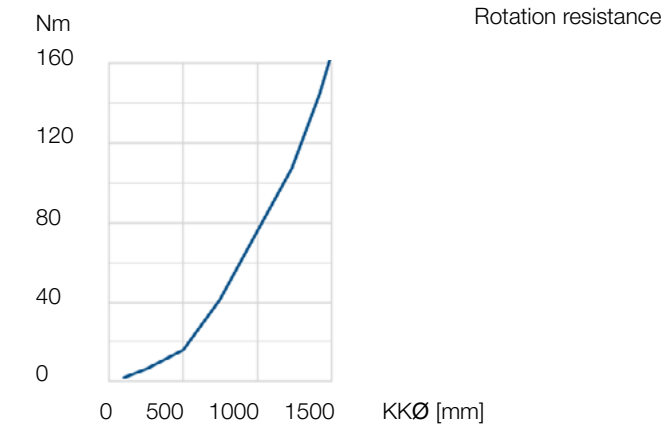

LER 4

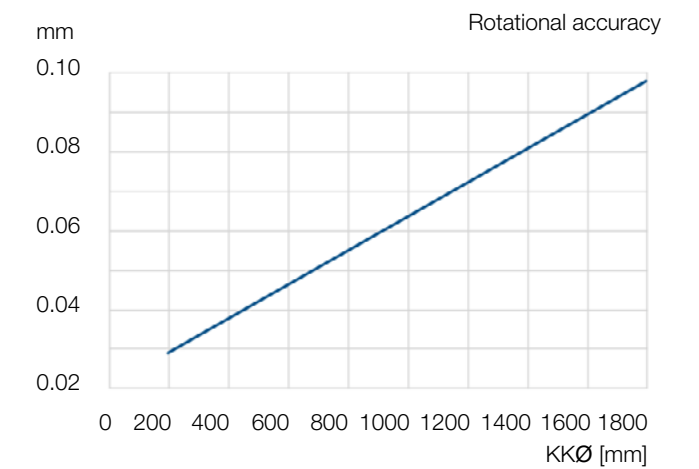
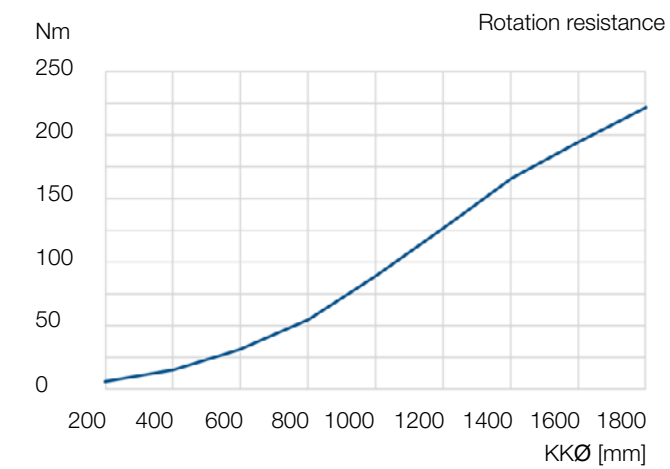

LER 5

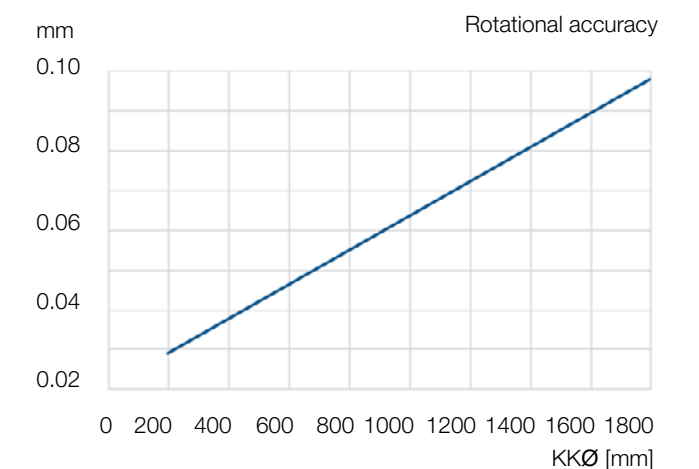
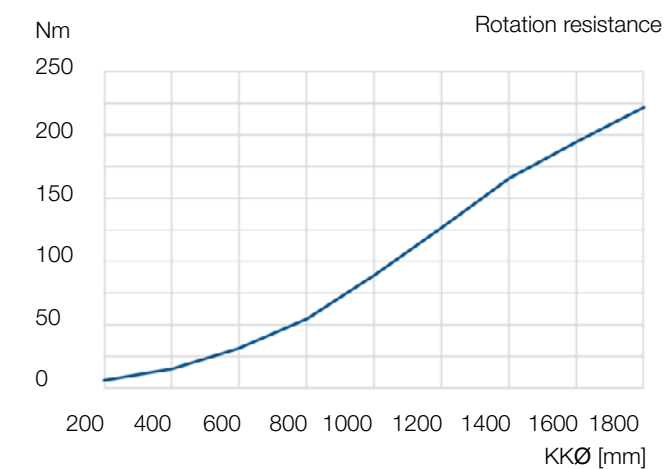

7. Assemble gaskets

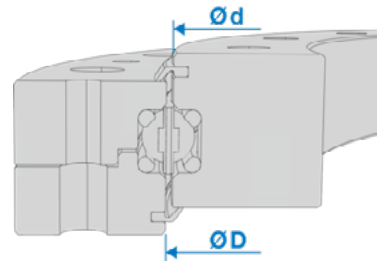

Calculate gasket length

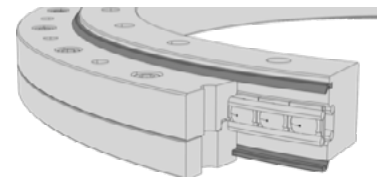

Gasket length

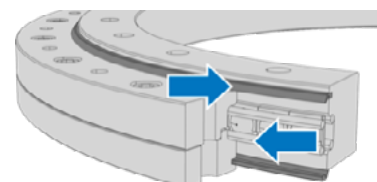

Insert gasket

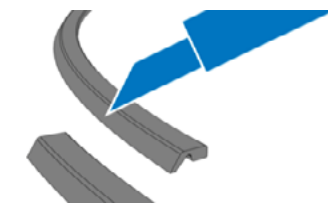

Cut off protruding ends

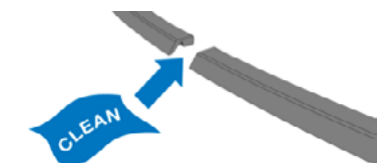

Clean cut edges



Bonding separation points

- 1 Use the following formula to calculate the gasket length.

Inner ring	$d * \pi + 25 \text{ mm}$
Outer ring	$D * \pi + 25 \text{ mm}$

- 2 Determine exact gasket length.



The formula for determining the gasket length gives a guide value. The final length of the gasket is determined when the gasket is inserted into the gasket groove.

- 3 Insert gasket.

- 4 Cut off protruding ends of the gasket to the appropriate length.



Cut gasket exactly perpendicular to length to create exact joints for bonding.

- 5 Remove the seal from the seal groove and clean the separation points so that they are completely free of grease.

- 6 Coat one of the separation points with a suitable adhesive (e.g. Loctite 401).

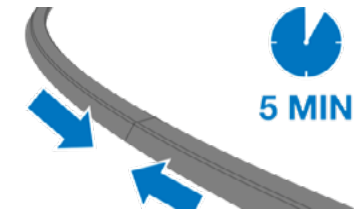

Press glued joints together

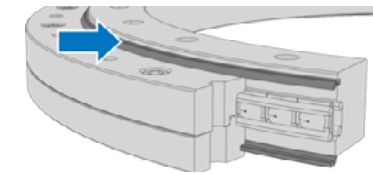

Insert gasket

- 7 Press the joints together for approx. 20 seconds and allow the adhesive to cure for 5 minutes. Then remove any excess and adhesive residue.

- 8 Reinsert the seal into the groove.

8. Maintenance

8.1 Safety instructions for maintenance

Improper
Maintenance work

WARNING!

Risk of injury due to improperly performed maintenance work!

- Ensure sufficient assembly clearance before starting work.
- Ensure tidiness and cleanliness at the assembly site!
- If components have been removed, ensure correct assembly, reinstall all fasteners and observe screw tightening torques.
- When cleaning the bearing, use suitable cleaning agents that are compatible with the seal. For this purpose, follow the instructions of the cleaning agent manufacturer.

Observe the following before recommissioning:

- Ensure that all maintenance work has been carried out and completed in accordance with the information and notes in this manual.
- Ensure that there are no persons in the danger zone.
- Ensure that all covers and safety devices are installed and functioning properly.

Incorrect maintenance

NOTE!

Material damage due to faulty maintenance

- Inspect slewing ring for corrosion every six months.
- Depending on the application (e.g. influence of vibrations), retighten the screw connections at regular intervals.
- If the bearing makes running noises, switch off the machine and determine the cause of the fault.
- Check the seals of the bearing at regular intervals.

Incorrect lubrication

NOTE!

Material damage to the bearing due to improper lubrication!

- Only use greases approved by the manufacturer (→ chapter 5.1 "Approved lubricants").
- Observe relubrication quantity and relubrication intervals (→ chapter 8.2.1 "Relubrication").
- Relubricate the bearing only at operating temperature.

At all lubrication points supplied with lubricant, remove the escaping, used or excess grease and dispose of it in accordance with the applicable local regulations..

8.2 Maintenance work

8.2.1 Relubrication

Lubricants



For long-term lubrication, use high-performance bearing lubricants due to their higher ageing resistance. Franke recommends the special lubricating grease „SHELL Gadus S3 V220 C2“ or comparable.

NOTE!

Material damage due to improper lubrication!

- Ensure that the lubricants are suitable for the respective application and for the materials used (e.g. rolling bearing cage or seal).
- When mixing lubricants, consider the compatibility of the lubricant types. In particular, note the base oil type, thickener, base oil viscosity and NGLI class. These questions must be clarified in advance with the lubricant manufacturer, especially if the bearing is used under extreme operating conditions.

Relubrication of the bearing

Relubrication takes place via the gap between the inner and outer ring.

- 1 Perform relubrication below the operating temperature of the bearing.
- 2 When relubricating, rotate the bearing.

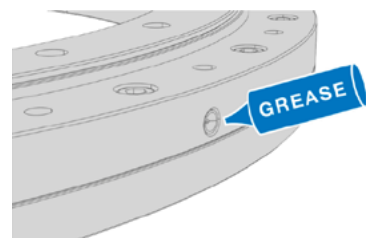

The relubrication period is application-specific. The following table shows reference values.

For recommended lubricants, see page 16.

Relubrication

Relubrication intervals

Peripheral speed in m/s	Relubrication interval in h
0 bis < 3	5000
3 bis < 5	1000
5 bis < 8	600
8 bis < 10	200

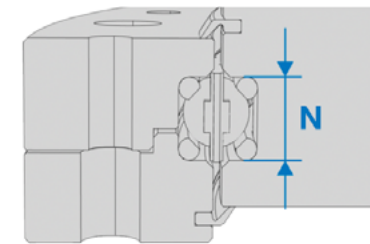

Wire bed height



Once the relubrication frequency has been determined, calculate the relubrication quantity using the following formula.

Relubrication quantity for bearing elements:

$$m = KK\varnothing * (N * 2) / 3 * x$$

m = relubrication quantity in grams

∅KK = ball ring diameter

M = wire bed height in millimeters

x = factor x in mm⁻¹ according to table for relubrication quantity

Wire bed height N for LV series:

KK100 - 350mm:	13 mm
KK400 - 1000mm:	17.5 mm
KK1200 - 1800mm:	20.9 mm

Relubrication	x in mm ⁻¹
Weekly	0.002
Monthly	0.003
Yearly	0.004
Every 2 - 3 years	0.005



When lubricating toothed bearings, automatic gear lubrication is recommended. In the case of manual lubrication, lubricate the gearing and pinions before commissioning.

Always contact customer service in the event of any uncertainties.

Lubricants:

Application area	Manufacturer	Description	Usage	Container	Order no.
Standard					
Universal applicable	Shell	Gadus	ex works in all bearing assemblies of the standard series LVA, LVB, LVC, LVD, LVE, LVG	400g	45176
Special					
High dynamics	Klüber	Isoflex Topas NCA52	at high speeds or traversing speeds	1kg	10004
High temperature	Klüber	Barrierta L55/2	for temperatures in ranges up to max. +260°C	180g	06439
Food safe	Klüber	Klübersynth UH1 64-1302	Paraffin-free for use e.g. in food production or pharmaceuticals	400g	47612
Clean room compatible, vacuum compatible	Klüber	Klüberalfa YV193-152	Special grease with high chem. Stability for use in extreme atmospheric environments	1kg/50g	48055

9. Tools and accessoires

9.1 Tools needed

- Torque wrench
- Dial gauge
- Allen wrench
- Screwdriver
- Surface cylindrical grinding machine (for massive tuning)
- Feeler gauge
- Spring scale (or similar)
- Lever for measuring the torque

9.2 Accessoires

The following accessories are optionally available:

- Reconciliation supplements
- Seals
- Spare balls (G25 according to DIN 5401) for bearing elements
- Retaining screws

10. Impressum

© Franke GmbH
 Obere Bahnstr. 64
 73431 Aalen
 Tel. +49 7361 920-0
 info@franke-gmbh.com
 www.franke-gmbh.com

All rights reserved.
 No liability for errors or
 printing mistakes.

This manual is also as a
 download (PDF) on our website.
www.franke-gmbh.com/downloads

Status: 16.January 2023